



**Contenitori in acciaio inox**  
***Stainless steel boxes***



**040**



Acciaio inox / stainless steel  
Principi costruttivi applicati / Construction principles applied

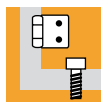
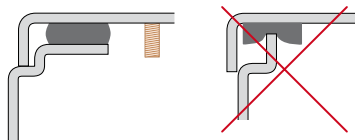
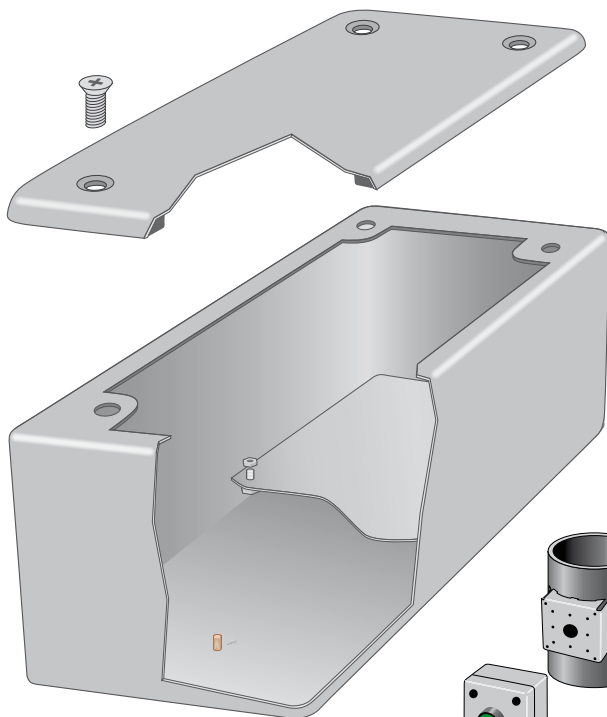
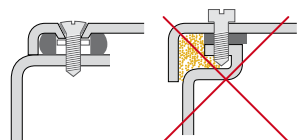
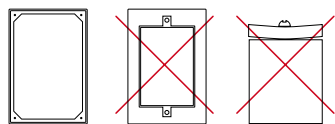

### RESISTENZA DEI CONTENITORI ALLA CORROSIONE

- assenza di corrosione in condizioni ottimali di impiego a contatto con le sostanze considerate
- possibilità di corrosione a contatto con le sostanze considerate
- dati non reperiti

	austenitici al Cr-Ni-Mo del tipo 316				austenitici al Cr-Ni-Mo del tipo 316			
	austenitici al Cr-Ni del tipo 302-304-305				austenitici al Cr-Ni del tipo 302-304-305			
	ferritici al Cr del tipo 430				ferritici al Cr del tipo 430			
	martensitici al Cr del tipo 410				martensitici al Cr del tipo 410			
acetilene (commerciale)	●	●	●	●				●
aceto	●	●	●	●				●
aceto (vapor)		●	●	●				●
acetone 100% a 100°C	●	●	●	●				●
acido acetico fino a 20%	○	●	●	●				●
acido boricco 5%	●	●	●	●				●
acido butirrico 5%	●	●	●	●				●
acido cianidrico 100%	○	○	●	●				●
acido citrico 5%	●	●	●	●				●
acido cloridrico (tutte le concentrazioni)	○	○	○	○				●
acido cromoico 5%		●	●	●				●
acido fluoridrico (tutte le concentrazioni)	○	○	○	○				●
acido fosforico 5%	●	●	●	●				●
acido lattico 5%	○	●	●	●				●
acido linoleico 100% fino a 100°C	●	●	●	●				●
acido malico 10-40% fino a 50°C		●	●	●				●
acido muriatico (commerciale)	○	○	○	○				●
acido nitrico fino a 10% a 80°C	●	●	●	●				●
acido oleico 100%	●	●	●	●				●
acido ossalico 5%	●	●	●	●				●
acido picrico (tutte le concentrazioni)	●	●	●	●				●
acido solfidrico 100% umido (idrogeno solforato)	○	○	●	●				●
acido solforico 5% bollente	○	○	○	○				●
acido solforico fumante (oleum) 50°C	●	●	●	●				●
acido solforoso 100%	○	○	●	●				●
acido stearico 100% fino a 100°C	●	●	●	●				●
acido tartarico 10% a 100°C	●	●	●	●				●
acqua dolce	●	●	●	●				●
acqua ossigenata 10-30%	●	●	●	●				●
acqua ragia	●	●	●	●				●
alcol etilico (tutte le concentrazioni)	●	●	●	●				●
alcol metilico 100%	●	●	●	●				●
alluminio fuso	○	○	○	○				●
ammoniaca 100% (secca)	●	●	●	●				●
anidride acetica 100%	○	○	○	○				●
anidride carbonica 100% (secca)	●	●	●	●				●
anidride solforosa 90%	○	○	○	○				●
anilina 100%	●	●	●	●				●
bagni di concia		●	●	●				●
bagni di cromatura		●	●	●				●
bagni di fissaggio fotografico	○	○	○	○				●
bagni di sviluppo fotografico	●	●	●	●				●
benzina	●	●	●	●				●
benzolo a freddo e a caldo	●	●	●	●				●
bicarbonato di sodio (tutte le concentrazioni)	●	●	●	●				●
birra		●	●	●				●
bisolfato di sodio 15% a 85°C	○	○	○	○				●
bisolfuro di carbonio 100%	●	●	●	●				●
borace 5% caldo	●	●	●	●				●
butano	●	●	●	●				●
caffè bollente	●	●	●	●				●
candeggina satura	○	○	○	○				●
canfora	●	●	●	●				●
carbonato di sodio 5% fino a 65°C	●	●	●	●				●
citrato di sodio a freddo e a caldo	●	●	●	●				●
clorofornio 100%	●	●	●	●				●
cloruro di ammonio 1%	●	●	●	●				●
cloruro ferrico 5-50%	○	○	○	○				●
cloruro ferroso 10-20%	○	○	○	○				●
cloruro di magnesio fino a 20%	○	○	○	○				●
cloruro di mercurico 10%	○	○	○	○				●
cloruro di nichel 10-30%	○	○	○	○				●
cloruro di potassio 1-5%	●	●	●	●				●
cloruro di sodio 5% (non agitato)	●	●	●	●				●
cloruro di zinco 10%								●
cloruro di zolfo 100% a temperatura di ebollizione	○	○	○	○				●
coca cola (sciropo puro)								●
etere 100%		●	●	●				●
formaldeide 100%		●	●	●				●
fosfato d'ammonio 10%		●	●	●				●
fosfate di sodio a tutte le concentrazioni		●	●	●				●
furfurulo 100% a temperatura di ebollizione	●	●	●	●				●
gas di cloro umido	○	○	○	○				●
gas di cokeria								●
gelatina	●	●	●	●				●
glicerina a tutte le concentrazioni	●	●	●	●				●
glicole etilico 100%	●	●	●	●				●
glucosio	●	●	●	●				●
gomma lacca	●	●	●	●				●
idrossido d'ammonio fino al 40%		●	●	●				●
idrossido di calcio fino a 10% fino a 100°C	●	●	●	●				●
idrossido di magnesio 10% fino a 100°C	●	●	●	●				●
idrossido di potassio fino a 50%	●	●	●	●				●
idrossido di sodio fino a 20%	●	●	●	●				●
ipoclorito di calcio 100%	○	○	○	○				●
ipoclorito di sodio 100%	○	○	○	○				●
latte (fresco o acido)	●	●	●	●				●
lievito	●	●	●	●				●
maionese	●	●	●	●				●
melassa	●	●	●	●				●
mostarda	●	●	●	●				●
nitrate d'ammonio 10-50%		●	●	●				●
nitrate di sodio 10-40%		●	●	●				●
oli minerali a caldo e a freddo	●	●	●	●				●
oli vegetali a caldo e a freddo	●	●	●	●				●
paraffina a caldo e a freddo	●	●	●	●				●
perborato di sodio 10% fino a 100°C	●	●	●	●				●
perossido di idrogeno 10%	●	●	●	●				●
perossido di sodio 10% fino a 100°C								●
piombo fuso	○	○	○	○				●
propano	●	●	●	●				●
sapone	●	●	●	●				●
sciropo di zucchero a tutte le concentrazioni	●	●	●	●				●
siero di latte	●	●	●	●				●
silicato di sodio fino a 100% fino a 100°C	●	●	●	●				●
solfato d'alluminio 10%	○	○	○	○				●
solfato di ammonio 10%	○	○	○	○				●
solfato ferrico 10%	●	●	●	●				●
solfato ferroso 10-40%	●	●	●	●				●
solfato di magnesio 10-40%	○	○	○	○				●
solfato di nichel 30%	●	●	●	●				●
solfato di potassio 10% fino a 100°C	●	●	●	●				●
solfato di rame 10%	●	●	●	●				●
solfato di sodio 10%	●	●	●	●				●
solfato di zinco 10%	●	●	●	●				●
solfo di sodio 10%	○	○	○	○				●
succhi di arancia concentrati	●	●	●	●				●
succhi di limone concentrati	●	●	●	●				●
tetracloruro di carbonio 10%	○	○	○	○				●
tiosolfato di sodio 10-60% fino a 100°C	●	●	●	●				●
toluolo	●	●	●	●				●
tricloroetilene 100% (trielina) fino a 100°C	●	●	●	●				●
vernici	●	●	●	●				●
vino	●	●	●	●				●
whisky	●	●	●	●				●
zinco fuso	○	○	○	○				●
zolfo fuso	●	●	●	●				●

dati provenienti da:  
**CORROSION GUIDE - E. Rabald - Elsevier, Amsterdam, London, New York 1968**  
**CORROSION DATA SURVEY - 4a ed. - G. A. Nelson NACE, Houston 1967**  
**CORROSION DATA SURVEY - 5a ed. - N. E. Hammer NACE, Houston 1967**

040/080



RESISTANCE OF BOXES TO CORROSION

- no corrosion in optimal conditions of use in contact with the substances considered
- possibility of corrosion when in contact with the substances considered
- corrosion when in contact with the substances considered
- data not available

	316 type austenitic Cr-Ni-Mo steel				316 type austenitic Cr-Ni-Mo steel			
	302-304-305 type austenitic Cr-Ni		430 type ferritic Cr steel		302-304-305 type Cr-Ni steel		430 type Cr steel	
	410 type martensitic Cr steel				410 type martensitic Cr steel			
acetylene (commercial)	●	●	●	●				●
vinegar	●	●	●	●				●
vinegar (vapours)		●	●	●				●
acetone 100% at 100°C	●	●	●	●				●
acetic acid up to 20%	○	●	●	●				●
boric acid 5%	●	●	●	●				●
butyric acid 5%	●	●	●	●				●
hydrocyanic acid 100%	○	○	●	●				●
citric acid 5%	●	●	●	●				●
hydrochloric acid (all concentrations)	○	○	○	○				●
chromic acid 5%		●	●	●				●
hydrofluoric acid (all concentrations)	○	○	○	○				●
phosphoric acid 5%	●	●	●	●				●
lactic acid 5%	○	●	●	●				●
linoleic acid 100% up to 100°C	●	●	●	●				●
malic acid 10-40% up to 50°C		●	●	●				●
malonic acid (commercial)	○	○	○	○				●
nitric acid up to 10% at 80°C	●	●	●	●				●
oleic acid 100%	●	●	●	●				●
oxalic acid 5%	●	●	●	●				●
picric acid (all concentrations)	●	●	●	●				●
wet sulphuric acid 100% (hydrogen sulphide)	○	○	●	●				●
boiling sulphuric acid 5%		○	○	○				●
fuming sulphuric acid (oleum) 50°C	●	●	●	●				●
sulphurous acid 100%	○	○	●	●				●
stearic acid 100% up to 100°C	●	●	●	●				●
tartaric acid 10% at 100°C	●	●	●	●				●
soft water	●	●	●	●				●
hydrogen dioxide 10-30%	●	●	●	●				●
white spirit		●	●	●				●
ethyl alcohol (all concentrations)	●	●	●	●				●
methyl alcohol 100%		●	●	●				●
melted aluminium	○	○	○	○				●
ammonia 100% (dry)	●	●	●	●				●
acetic anhydride 100%	○	○	●	●				●
carbon dioxide 100% (dry)	●	●	●	●				●
sulphur dioxide 90%	○	○	○	●				●
aniline 100%	●	●	●	●				●
tanning bath		●	●	●				●
chromium plating bath		●	●	●				●
fixing bath		○	○	○				●
developer bath		●	●	●				●
gasoline	●	●	●	●				●
cold and hot benzol	●	●	●	●				●
sodium bicarbonate (all concentrations)	●	●	●	●				●
beer		●	●	●				●
sodium disulphate 15% at 85°C	○	○	○	○				●
carbon bisulphide 100%	●	●	●	●				●
hot borax 5%	●	●	●	●				●
butane	●	●	●	●				●
boiling coffee	●	●	●	●				●
saturated chlorine water	○	○	○	●				●
camphor		●	●	●				●
sodium carbonate 5% up to 65°C	●	●	●	●				●
hot and cold sodium citrate (all concentrations)		●	●	●				●
chloroform 100%	●	●	●	●				●
ammonium chloride 1%	●	●	●	●				●
ferric chloride 5-50%	○	○	○	○				●
ferric chloride 10-20%	○	○	○	○				●
magnesium chloride up to 20%	○	○	○	○				●
mercury chloride 10%	○	○	○	○				●
nickel chloride 10-30%	○	○	○	○				●
potassium chloride 1-5%	●	●	●	●				●
sodium chloride 5% (not agitated)	●	●	●	●				●
zinc chloride								●
sulphur chloride 100% at boiling temperature	○	○	○	○				●
coca cola (pure syrup)	●	●	●	●				●
ether 100%	●	●	●	●				●
formaldehyde 100%	●	●	●	●				●
ammonium phosphate 10%	●	●	●	●				●
sodium phosphate at all concentrations	●	●	●	●				●
furfural 100% at boiling temperature	●	●	●	●				●
wet chloride gas	○	○	○	○				●
coke-oven gas	●	●	●	●				●
gelatine	●	●	●	●				●
glycerol at all concentrations	●	●	●	●				●
ethyl glycol 100%	●	●	●	●				●
glucose	●	●	●	●				●
shellac	●	●	●	●				●
ammonium hydroxide up to 40%		●	●	●				●
calcium hydroxide up to 10% up to 100°C	●	●	●	●				●
magnesium hydroxide 10% up to 100°C	●	●	●	●				●
potassium hydroxide up to 50%	●	●	●	●				●
sodium hydroxide up to 20%	●	●	●	●				●
calcium hypochlorite 100%	○	○	○	○				●
sodium hypochlorite 100%	○	○	○	○				●
milk (fresh or acid)	●	●	●	●				●
yeast		●	●	●				●
mayonnaise		●	●	●				●
molasses		●	●	●				●
mustard		●	●	●				●
ammonium nitrate 10-50%		●	●	●				●
sodium nitrate 10-40%		●	●	●				●
hot and cold mineral oil		●	●	●				●
hot and cold vegetable oil		●	●	●				●
hot and cold paraffin		●	●	●				●
sodium perborate 10% up to 100°C	●	●	●	●				●
hydrogen peroxide 10%	●	●	●	●				●
sodium peroxide 10% up to 100°C	●	●	●	●				●
melted lead	○	○	○	○				●
propane	●	●	●	●				●
soap		●	●	●				●
sugar syrup at all concentration		●	●	●				●
whey		●	●	●				●
sodium silicate up to 100% up to 100°C	●	●	●	●				●
aluminium sulphate 10%	○	○	○	○				●
ammonium sulphate 10%	○	○	○	○				●
ferric sulphate 10%	●	●	●	●				●
ferric sulphate 10-40%	●	●	●	●				●
magnesium sulphate 10-40%	○	○	○	○				●
nickel sulphate 30%		●	●	●				●
potassium sulphate 10% up to 100°C	●	●	●	●				●
copper sulphate 10%	●	●	●	●				●
sodium sulphate 10%	●	●	●	●				●
zinc sulphate 10%	●	●	●	●				●
sodium sulphide 10%	○	○	○	○				●
concentrated orange juice		●	●	●				●
concentrated lemon juice		●	●	●				●
carbon tetrachloride 10%	○	○	○	○				●
sodium thiosulphate 10-60% up to 100°C	●	●	●	●				●
toluol	●	●	●	●				●
trichloroethylene 100% up to 100°C	●	●	●	●				●
paints	●	●	●	●				●
wine		●	●	●				●
whisky		●	●	●				●
melted zinc	○	○	○	○				●
melted sulphur	●	●	●	●				●

data taken from:  
**CORROSION GUIDE - E. Rabald - Elsevier, Amsterdam, London, New York 1968**  
**CORROSION DATA SURVEY - 4a ed. - G. A. Nelson - NACE, Houston 1967**  
**CORROSION DATA SURVEY - 5a ed. - N. E. Hammer - NACE, Houston 1967**

040/080



## UN BREVE CENNO STORICO

Gli acciai inossidabili sono dei materiali entrati nella produzione industriale relativamente da poco tempo. gli esperti fanno risalire al primo ventennio del novecento la loro prima comparsa in nuove applicazioni. Infatti alla fine del 1912 il metallurgista Passel della Krupp, depositò in Germania due brevetti (che furono poi rilasciati nel 1918 con i numeri 304 126 e 304 159) in cui si parla di acciai inossidabili austenitici contenenti 18 parti di cromo e 8 parti di nichel.

La prima colata industriale di acciaio merlettensico al solo cromo avvenne nel 1913 in Gran Bretagna; il prodotto di questa prima colata, che conteneva circa il 13% di cromo, servì a costruire lame di coltelli. Le prime applicazioni, oltre alla coltelleria già menzionata, avvennero nei motori a combustione interna durante la prima guerra mondiale, mentre la diffusione in tutti i settori d'impiego iniziò dopo gli anni 20 e lo sviluppo continua ancora oggi in settori avanzati e particolarmente "esigenti", come in quello della produzione petrolchimica, alimentare, farmaceutico, zootecnico ecc.



## RESISTENZA ALLA CORROSIONE

Gli acciai inossidabili sono delle leghe a base di ferro, di cromo, carbonio e di altri elementi quali nichel, molibdeno, manganese, silicio, titanio ecc., che li rendono particolarmente resistenti ad alcuni tipi di corrosione. La norma EN 10088 definisce acciai inossidabili quelle leghe ferrose che contengono cromo in ragione di almeno il 10,5%. La caratteristica di buona resistenza è dovuta alla proprietà di queste leghe di passivarsi in un ambiente sufficientemente ossidante (per esempio l'aria) tramite la formazione di una particolare pellicola superficiale di ossigeno assorbito. Quando è in queste condizioni l'acciaio inossidabile è allo stato "passivo".

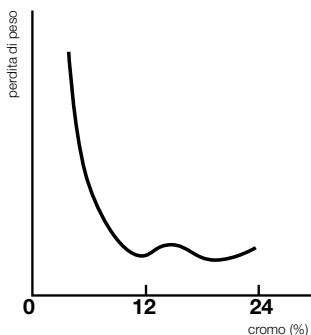

La curva mostra come la percentuale di cromo in lega determini il minimo della perdita di peso in ambiente corrosivo.

La pellicola passiva si riforma quando viene lacerata, naturalmente se l'ambiente è sufficientemente ossidante e se l'ossigeno può pervenire a contatto della lega. Essa protegge il materiale sottostante dall'attacco corrosivo.



Da un punto di vista logico verrebbe fatto d'osservare che questi materiali dovrebbero essere denominati "**ossidabilissimi**" piuttosto che "**inossidabili**", proprio in funzione del loro meccanismo di protezione contro la corrosione. L'aggettivo inossidabile è riferito all'acciaio soltanto negli anni '20 formando la dizione "**acciaio inossidabile**" oggi in uso. Anche altre lingue neolatine, ad esempio la francese con inoxydable e la spagnola con inoxidable, designano con il significato di "**non corrodibile**" questo tipo di materiale. Altre lingue d'origine non latine, essenzialmente pragmatiche e meno fantasiose, utilizzano altri termini per definire questo materiale. Il tedesco lo definisce "**rostfrei**" (libero da ruggine) oppure "**nichtrostender**" (non corrodibile), lo svedese "**rostfritt**" (libero da ruggine) e l'inglese "**stainless**" (senza macchia).



## GUIDA AD UN CORRETTO UTILIZZO DELLE CONTENITORI IN ACCIAIO INOX

La New Elfin fornisce tutte le Contenitori in acciaio inox rivestite di un film plastico adesivo, originariamente applicato in fase di laminazione, per proteggere il materiale in tutti i cicli di lavorazione<sup>(1)</sup> necessari per costruire i contenitori. Questo strato protettivo continua la sua funzione protettiva presso la clientela sia nel primo immagazzinamento<sup>(2)</sup> che per le lavorazioni di allestimento. E' però indispensabile che, a completamento del lavoro, la pellicola venga rimossa per attivare, al contatto con l'aria, il processo di passivazione che rende l'acciaio resistente alla corrosione. E' quindi evidente che questa operazione deve essere compiuta prima di inserire i contenitori nell'ambiente di lavoro o comunque corrosivo.

(1) Stoccaggio, taglio laser, piegatura, saldatura, montaggio ecc.

(2) Non riporre su scaffalature con piani in metallo arrugginito o corrosi, si raccomandano piani in legno o rivestiti con carta oleata.



### A SHORT HISTORICAL BACKGROUND

The use of stainless steel in industrial production is fairly recently. The experts date the first appearance in new applications back to the first twenty years of the twentieth century. At the end of 1912, the metallurgist Pasel of Krupp filed two patents in Germany (which were then issued in 1918 with the numbers 304 126 and 304 159) which mention austenitic stainless steels containing 18 parts of chromium and 8 parts of nickel.

Mertensitic steel with chromium was cast for the first time in Great Britain in 1913; the product of this first heat, which contained around 13% chromium, was used to manufacture knife blades. Apart from knives as mentioned above, the first applications of stainless steel were in internal combustion engines during the First World War whereas they began to be employed on a widescale basis in all sectors of use after the 1920's and development continues today in the more advanced and particularly "demanding" sectors such as the petrochemical, food and pharmaceutical industries and for animal husbandry, etc.



### RESISTANCE TO CORROSION

Stainless steels are alloys based on iron, chromium, carbon and other elements such as nickel, molybdenum, silicon, titanium, etc. that make them particularly resistant to certain types of corrosion. The EN 10088 specification defines stainless steels as ferrous alloys with an at least 10.5% chromium content. Their good resistance to corrosion is to be ascribed to their ability to passivate in a sufficiently oxidising environment (for example air) through formation of a particular surface film of adsorbed oxygen. When in these conditions, the stainless steel is in the "passive" status.

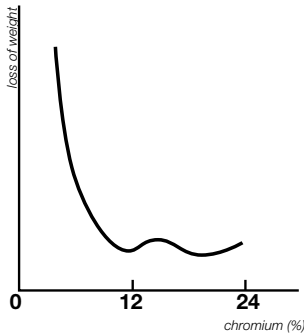

The curve shows how the percentage chromium in the alloy determines the minimum weight loss in a corrosive environment.

The passive film is reformed when it is torn obviously if the environment is sufficiently oxidising and if the oxygen can come into contact with the alloy. It protects the underlying material from attack by corrosion.



Logically speaking, it could be said that these materials should be called "highly oxydable" rather than "stainless" because of their protection mechanism against corrosion. The adjective "stainless" was used to refer to the steel only in the 1920's forming the designation "stainless steel" used today. The other Romance languages, for example French with *inoxydable* and Spanish with *inoxidable*, call this type of material "not liable to corrosion". Other non-Latin languages, more pragmatic and less imaginative, use other terms to define this material. In German it is called "rostfrei" (free of rust) or "nichtrostender" (not liable to corrosion), in Swedish "rostfritt" (free of rust) and in English "stainless".



### GUIDE TO CORRECT USE OF STAINLESS STEEL BOXES

New Elfin furnishes all stainless steel boxes covered with an adhesive plastic film applied originally during the milling phase to protect the material in all phases of the container construction process (1). This protective layer continues to perform its protective function at the customer site during both initial stocking (2) and during set-up processes. However, to complete the work, the film must be removed in order to activate, through contact with the air, the process of passivation that makes the steel resistant to corrosion. Obviously, this operation must be carried out before introducing the containers in the working or corrosive environment.

(1) Stocking, laser cutting, bending, welding, assembly, etc.

(2) Do not stock on shelves with rusted or corrosive metal surfaces; use of wood shelves or covered with greased paper is recommended.



Classificazione degli Acciai Inossidabili / Classification of stainless steel

E' opportuno conoscere il metodo di classificazione internazionale adottato dall' AISI<sup>(1)</sup> per fare riferimento alle sigle che troveremo nel proseguio del catalogo.

- acciai austenitici al cromo-manganese-nichel sono designati da un numero di tre cifre iniziante con la cifra 2, come ad esempio 2xx, dove la seconda coppia di cifre (qui indicate genericamente con xx) non ha nessun riferimento all'analisi del materiale, ma semplicemente serve a distinguere un tipo da un altro;
- acciai austenitici al cromo-nichel sono designati da un numero di tre cifre iniziante con la cifra 3, come ad esempio 3xx, dove la seconda coppia di cifre (qui indicate genericamente con xx) non ha nessun riferimento all'analisi del materiale, ma semplicemente serve a distinguere un tipo da un altro;
- acciai ferritici e martensitici al solo cromo sono designati da un numero di tre cifre iniziante con la cifra 4, come ad esempio 4xx, dove la seconda coppia di cifre (qui indicate genericamente con xx) non ha nessun riferimento all'analisi del materiale, ma semplicemente serve a distinguere un tipo da un altro;

*It is advisable to know the international classification method used by AISI(3) in order to refer to the codes given below in the catalogue.*

- chromium-manganese-nickel austenitic steels are identified by a 3-digit number starting with 2, such as 2xx, where the second set of digits (generally indicated with xx) makes no reference to the analysis of the material but is used simply to distinguish one type from another;
- chromium-nickel austenitic steels are identified by a 3-digit number starting with 3, such as 3xx, where the second set of digits (generally indicated with xx) makes no reference to the analysis of the material but is used simply to distinguish one type from another
- ferritic and martensitic chromium-only steels are identified by a 3-digit number starting with 4, such as 4xx, where the second set of digits (generally indicated with xx) makes no reference to the analysis of the material but is used simply to distinguish one type from another;

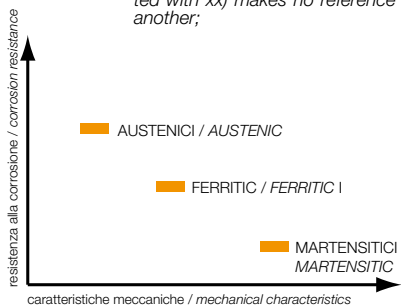

Il diagramma illustra il comportamento degli acciai, ed evidenzia come sia inversamente proporzionale il rapporto tra le caratteristiche di resistenza alla corrosione e quelle meccaniche, tra le classi degli austenitici e dei martensitici. La New Elfin ha realizzato i suoi contenitori utilizzando un acciaio austenitico AISI 316 conferendo al prodotto elevate caratteristiche di resistenza alla corrosione<sup>(2)</sup> e, grazie ad un attento progetto costruttivo, ha mantenuto alte caratteristiche meccaniche.

*The diagram illustrates the behaviour of the steels and highlights how the relationship between the corrosion resistance and mechanical characteristics is in inverse proportion, between the classes of austenitic and martensitic steels. New Elfin has produced its containers using an AISI 316 austenitic steel, endowing the product with high-level corrosion resistance characteristics<sup>(2)</sup> and, through an attentive construction project, has maintained high level mechanical characteristics.*



Caratteristiche tecniche dei contenitori New Elfin

Technical characteristics of New Elfin boxes

**MATERIALE CONTENITORI / MATERIAL**

Acciaio inox AISI 316 / AISI 316 stainless steel

**MATERIALE PIASTRE DI FONDO / BASE PLATE MATERIAL**

Acciaio zincato / Galvanized steel

**SERRAGGI / FASTENERS**

Chiusura coperchio con viti TSB 5MA imperdibili; morsetto di messa a terra inserto filettato 5MA su coperchio e fondo scatola, dado non fornito; dai formati 140 X 180 n. 4 inserti per fissaggio piastre di fondo  
*Cover closing with TSB 5MA captive screws; 5MA threaded insert ground terminal on the cover and bottom of box, nut not provided; from formats XXX to YYY n. 4 users for bottom plate fastening*

**GUARNIZIONE / SEAL**

Gomma neoprenica espansa a cellule chiuse, antiolio e autoestinguente, realizzata in un unico pezzo privo di giunzioni  
*Closed cell, anti-oil and self-extinguishing neoprene foam rubber constructed in a single piece without join.*

**FINITURA / FINISHING**

Scatole e coperchi satinati tipo Scotch-Brite privi di saldature a vista  
*Scotch-Brite satin finish boxes and covers without welds in sight.*

**GRADO DI PROTEZIONE / PROTECTION RATING**

IP66 - CEI EN 60529 / IP66 - CEI EN 60529

**LIMITI DI TEMPERATURA / TEMPERATURE LIMITS**

-40° ÷ +100°C / -40° ÷ +100°C



Acciaio Inox / Stainless steel **82 x 82 mm**



Coperchio / Cover			
	85	360	040X0808-8

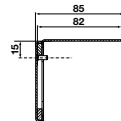

Coperchio / Cover			
1 Ø 22	85	357	040X0808-8P1

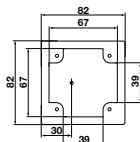

CASSETTA PULSANTIERA CONFIGURATA CON OPERATORE Ø 22



Funzione Operation		Coperchio Cover		
	85	Pulsante fungo rosso aggancio scatto <i>Red fast mushroom button</i>	483	040X0808-8GA

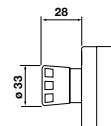

040/080



Acciaio Inox / Stainless steel **82 x 142 mm**

Coperchio / Cover			
	85	536	040X0814-8



Coperchio / Cover			
2 Ø 22	85	530	040X0814-8P2

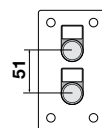

Coperchio / Cover			
3 Ø 22	85	527	040X0814-8P3

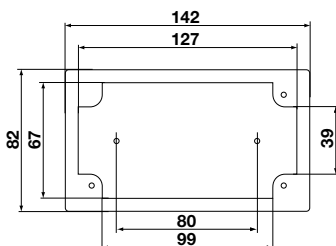
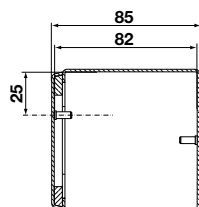
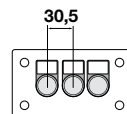





Coperchio / Cover			
	85	826	040X0820-8



Coperchio / Cover			
<b>3</b> Ø 22	85	817	040X0820-8P3

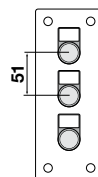

Coperchio / Cover			
<b>5</b> Ø 22	85	811	040X0820-8P5L

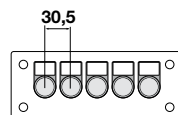

Coperchio / Cover			
<b>6</b> Ø 22	85	808	040X0820-8P6

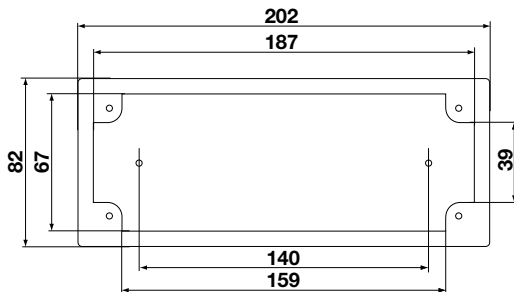
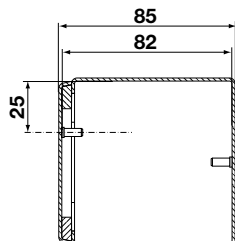
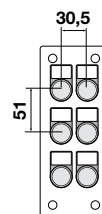



Acciaio Inox / Stainless steel 140 x 180 mm



Coperchio / Cover			
	125	1226	040X1418-12



Coperchio / Cover			
9 Ø 22	125	1200	040X1418-12P9

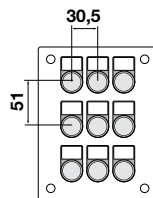

040/080

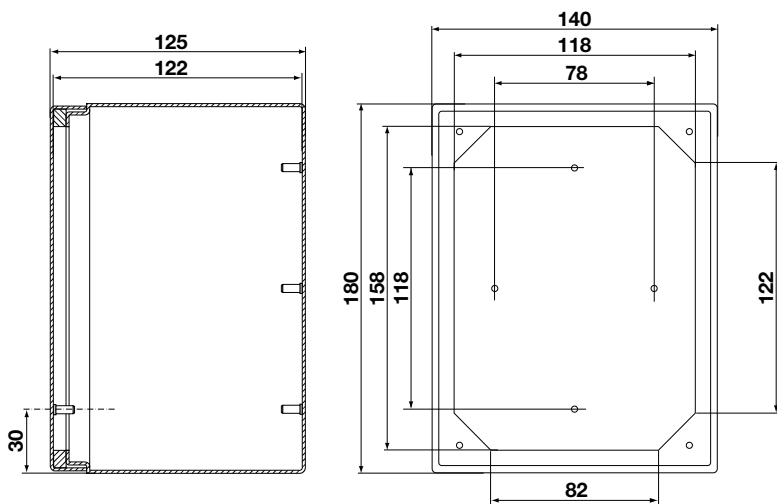



Coperchio / Cover			
	125	1392	040X1820-12



Coperchio / Cover			
<b>15</b> Ø 22	125	1347	040X1820-12P15

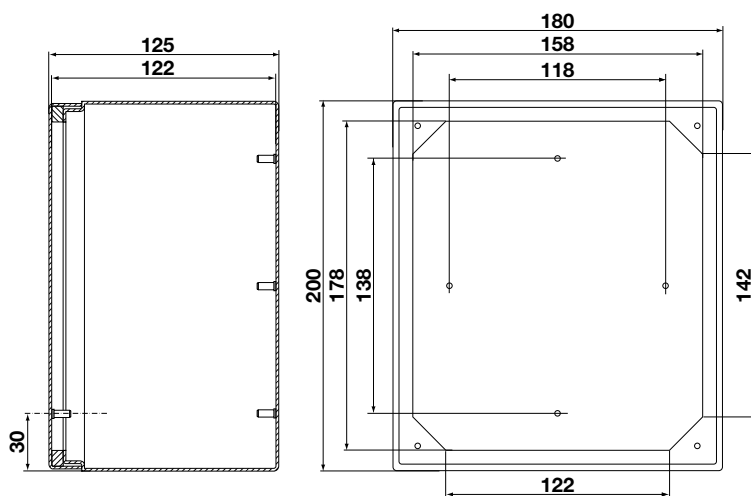
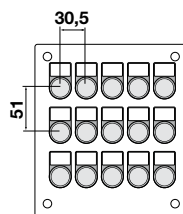

**040/080**



Acciaio Inox / Stainless steel **180 x 260 mm**



Coperchio / Cover			
	125	1712	040X1826-12



Coperchio / Cover			
20 Ø 22	125	1652	040X1826-12P20

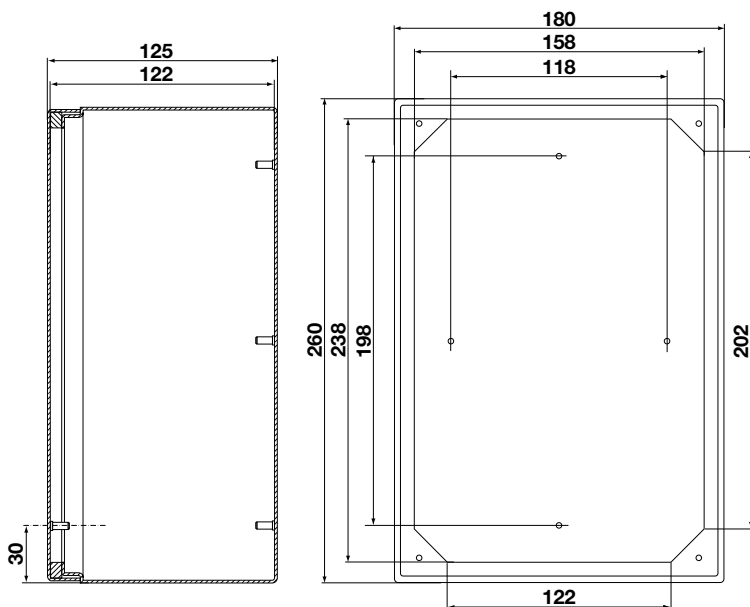
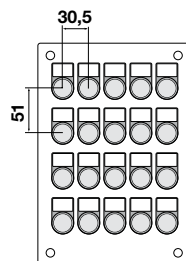

040/080



Coperchio / Cover	Altezza	gr.	
	125	2283	040X2326-12



Coperchio / Cover	Altezza	gr.	
<b>24 Ø 22</b>	125	2211	040X2326-12P24

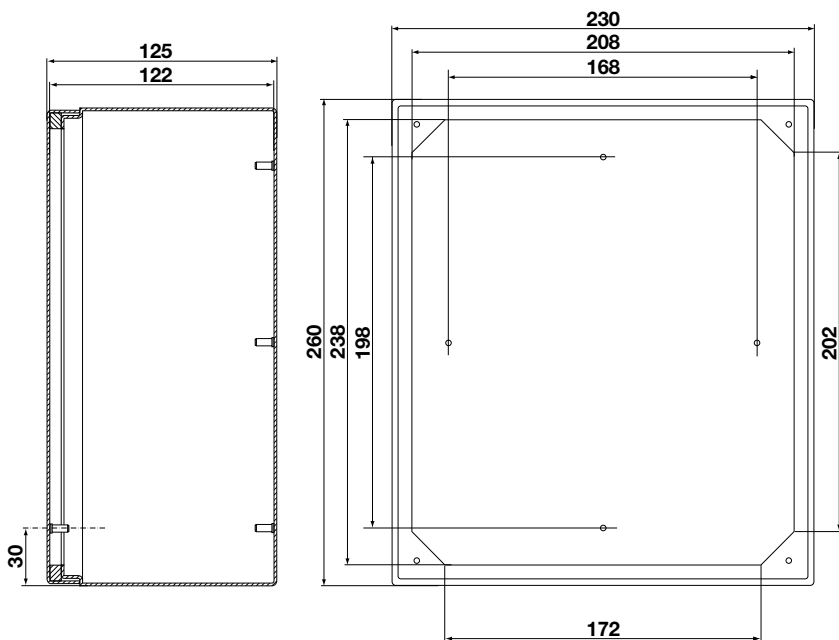
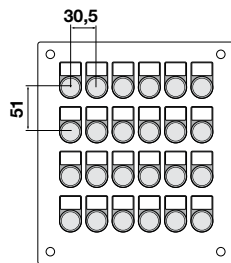

040/080



new



	74	Piastra / Plate	040P0814
--	----	-----------------	----------



	109	Piastra / Plate	040P0820
--	-----	-----------------	----------

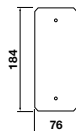

	162	Piastra / Plate	040P1418
--	-----	-----------------	----------

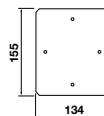

	235	Piastra / Plate	040P1820
--	-----	-----------------	----------

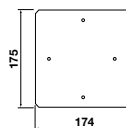

	318	Piastra / Plate	040P1826
--	-----	-----------------	----------

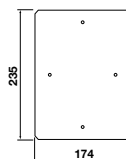

	410	Piastra / Plate	040P2326
--	-----	-----------------	----------

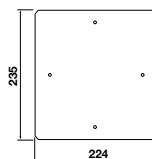

	48	Coppia piastre parete Wall brackets couple	040XSP
--	----	---	--------

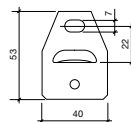

	760	Guida / Rail Ω 35 PVC	010GDP
--	-----	-----------------------	--------

L = 2000